



# SENATOR™ G2 MOUNTING SKID

  
**4060 - 5075**  
280-350 BAR  
**PSI**

  
**20 - 31**  
**L/PM**



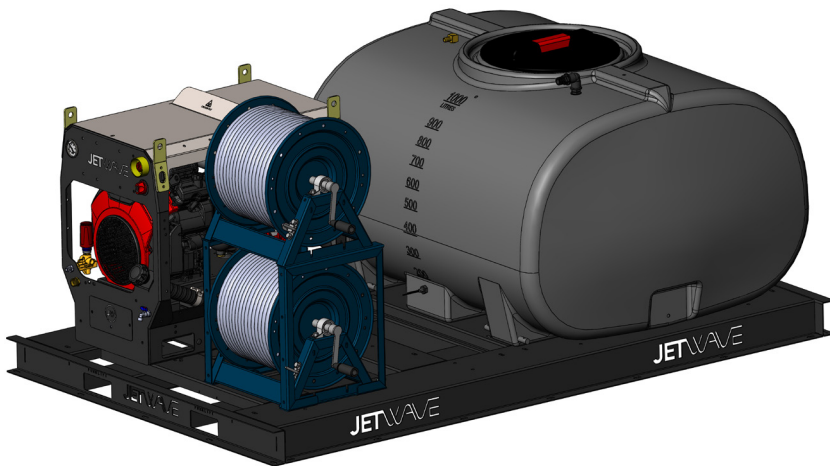

  
**HONDA**  
**V-TWIN & EFI**  
PETROL  
ENGINE TYPE  
POWERED by  
**HONDA**

  
**1000L**  
**WATER TANK**  
**CAPACITY**



  
**A FRAME**  
**HOSE REELS**



## HERO INNOVATIONS





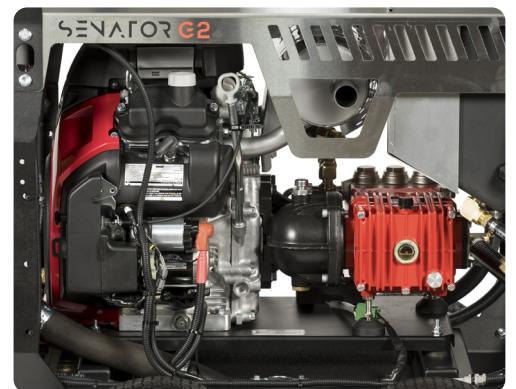

-  **TURN KEY SOLUTION**  
Quality assured and ready to work
-  **PURPOSE BUILT**  
Built for high pressure water equipment
-  **AUSTRALIAN MADE**  
Made for tough Australian conditions
-  **FORKLIFT POCKETS**  
Integrated mounting points
-  **STANDARD SIZE**  
To fit many types of setups

## APPLICATIONS

-  Portable High Pressure Cleaning
-  Truck, Ute & Trailer Mounting



## STANDOUT FEATURES

-  Skid design with integrated forklift pockets and mounting points.
-  Generic size to fit most, utes, trucks and some trailers.
-  Galvanised construction then powdered coated.
-  On-board 1000L water tank, with low level water cut out protection and high flow inlet float valve.
-  **G2** All in one solution ready to mount and work.
-  Industrial A-Frame high & low pressure hose reels, 30m high pressure hose & 30m inlet feed hose fitted.

## STANDARD EQUIPMENT



A-Frame Low Pressure Reel + 30m 3/4" Low Pressure Inlet Hose  
A Frame High Pressure Reel + 30m 3/8" Non Marking Double Wire Braid Hose w/M22 Couplings  
Double Stack Hose Reel Kit



1000L TTI On-board Water Cartage Tank & Float Valve w/Low Level Cut Out



Senator G2 Machine w/J5500K Gun & Lance accessories.

## DIMENSIONS (MM)

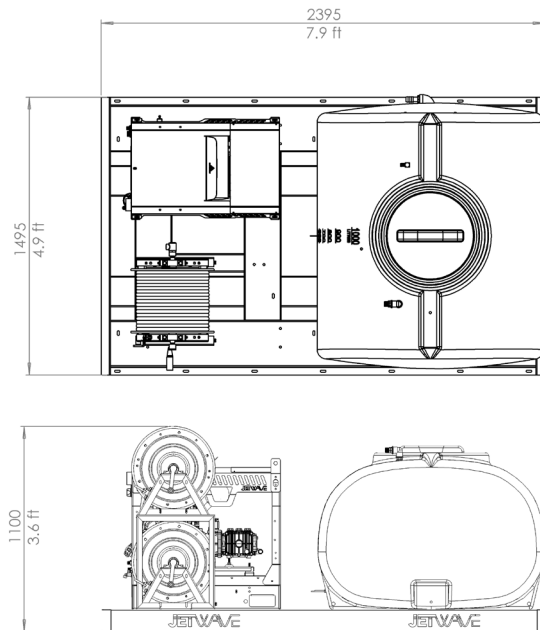

## SKID FEATURES

## SENATOR™ G2 MOUNTING SKID

Product Codes

CW4000-21PEG21000LSKID | CW4000-26PEG21000LSKID  
CW4000-31PEG21000LSKID | CW5000-23PEG21000LSKID

Origin

Made in Australia

Material Finish

CNC modular skid galvanised steel chassis plus satin powder coat finish

## WATERTANK FEATURES

Origin

Made in Australia

Tank Fill Lid

Y (w/hinged lid with no spill lip)

UV Stabilised

Y

Tank Capacity

1000L

Material

Polyethylene 'Tuff-Flex Molecular Technology'

Gauge

Easy to read calibrated measurements

## DIMENSIONS & WEIGHT

Total Dimensions

2395mm(L) x 1495mm(W) x 1100mm(H)

Total Weight (approx.)

650KG (dry) / 1650KG (wet)

## HOSE REELS

Type

2 x Apache A-Frame w/double stack kit

Capacity

Upto 100m of 3/8" High Pressure Hose

## WARRANTY(S)

Mounting Skid Warranty

 1 Years

Water Tank Warranty

 15 Years

## OPTIONAL UPGRADES

Add 30m High Pressure Hose (Total 60m) 52001-ADD30M

Add 70m High Pressure Hose (Total 100m) 52001-ADD70M

Apache A-Frame Hose Reel Guides 2100463

12v Rewind & Variable Speed Controller Kit 103166-CMPL

Copyright © 2023 Jetwave® Group Pty Ltd. All Rights Reserved.

The manufacturer reserves the right to modify design features and technical facts without notice, due to our principals of continuous improvement.

\*Coverage against defects in material and workmanship (refer to Jetwave's and component partners T&Cs).

V3.0 06/23