

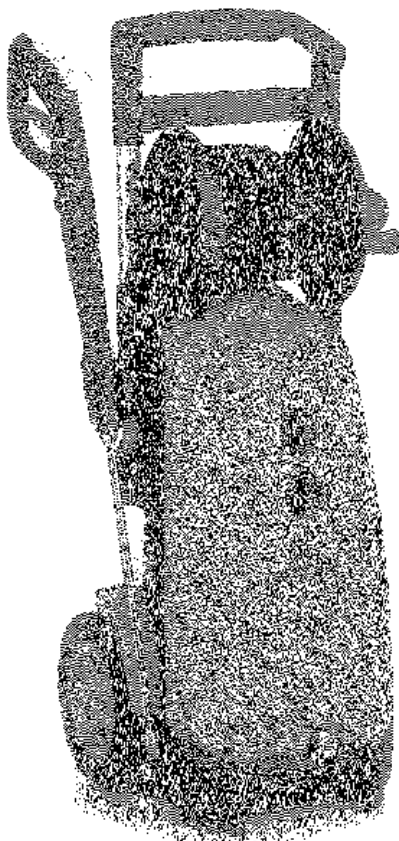

RAIDER 8.130

Cold Water Electric High Pressure
Water Cleaner User Manual

Part no. 11183



Warning: Read the instructions before using the machine.

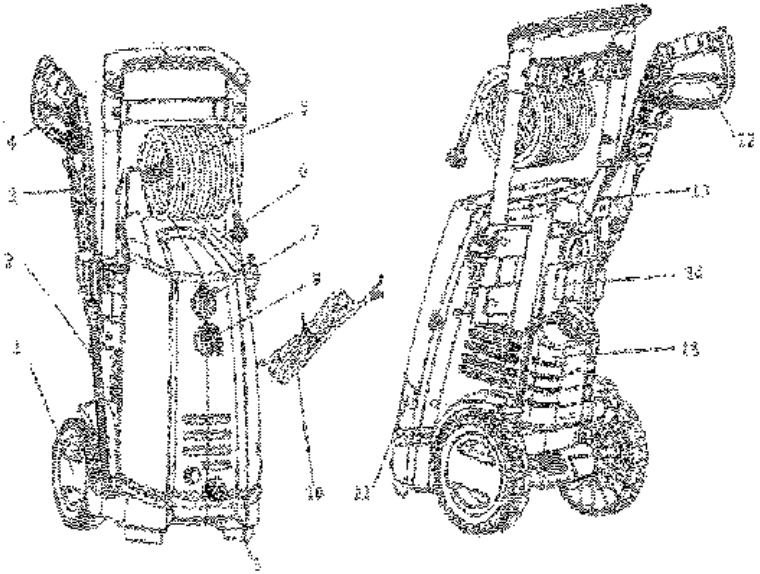

Fig. 1

Fig. 2



Fig. 3

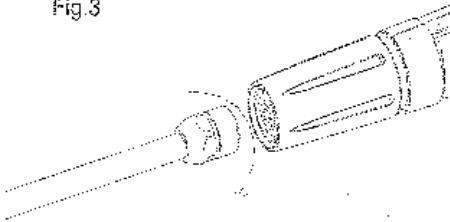

Fig. 4



Fig.5

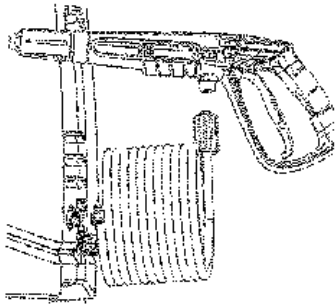

Fig.6

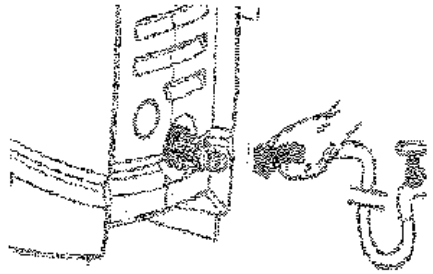

Fig.7

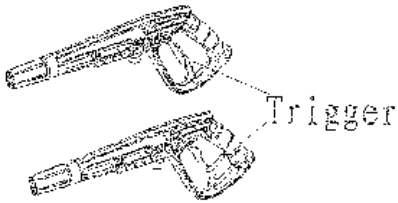

Fig.8

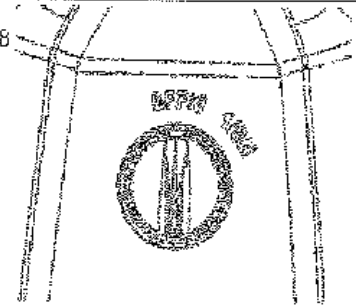

Fig. 9

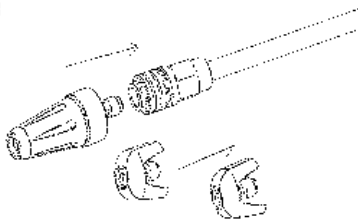

Fig.10

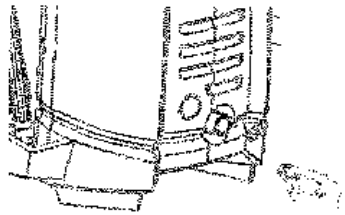

Fig.11



Fig.12



Fig.13





Congratulations!

Welcome to the world high pressure water cleaning. As the proud new owner of Jetwave Industrial Equipment's Raider 8.130 cold water electric high pressure water cleaner, you can be rest assured that you have purchased a convenient, efficient, and high-quality product.

To view our full range of Jetwave products, visit our website at www.jetwave.com.au















1. TECHNICAL DATA

	11183
	AC240V, 50Hz
	3.3hp
	I
	iFX5
	130 bar
	170 bar
	3 l/min
	8.5/min
	0-40°C
	0.7MPa
	LpA=77 dB(A) KPA=3dB
	LwA=86dB (A)
	$a \beta = 1.8 \text{ m/s}^2$ $K_{\text{LH}} = 0.05 \text{ m/s}^2$
	21.5kg







2. SYMBOLS USED TO MARK INSTRUCTIONS

Some of the following symbols may be used on this product. Please study them and learn their meaning for safe operation.

	Read Instruction	Before starting up your high pressure washer for the first time read this instruction manual carefully. Save the instructions for later use.
	Safety Alert	Safety instructions marked with this symbol must be observed to prevent danger to persons.
	Safety Mark	This symbol is used to mark safety instructions that must be observed to prevent damage to the machine and its performance.
	Indication Mark	This symbol indicates tips and instructions to simplify work and to ensure a safe operation.
	Waste Products Disposal	Waste electrical products should not be disposed of with household waste. Please recycle where facilities exist. Check with your local authority or retailer for recycling advice.
	Eye Protection	Always wear safety goggles or safety glasses with side shields or a full face shield when operating this product.
	Class II Construction	Double-insulated construction.
	Keep Bystanders Away	To reduce the risk of injury, user must keep all bystanders at least 15m away.
	Electric Shock Precaution	Remove plug from the mains immediately if cable is damaged or cut.
	Sound Power Level	Sound power level is 86dB(A).
	Electrical Shock Hazard	Electrical shock hazard.
		Machine not suitable for connection to the potable water mains.



The following signal words and meanings are intended to explain the levels of risk associated with this product.

	Danger	Indicates an imminently hazardous situation which, if not avoided, will result in death.
	Warning	Indicates a potentially hazardous situation which, if not avoided, could result in death or serious injury.
	Caution	Indicates a potentially hazardous situation which, if not avoided, may result in minor or moderate injury.
	Caution	(Without Safety Alert Symbol) Indicates a situation that may result in property damage.

3. IMPORTANT SAFETY INSTRUCTIONS



WARNING!

This appliance is not intended for use by children or other persons without assistance or supervision if their physical, sensory or mental capabilities prevent them from using it safely. Children should be supervised to ensure that they do not play with the appliance.

Before starting up your machine please check it carefully for any defects. If you find any, do not start up your machine and contact your distributor.

Check the following:

- The insulation of the power cord should be faultless and without any cracks. If the power cord is damaged, an authorized distributor should replace it.

WARNING!

Warning: Do not use this appliance without reading this instruction sheets.

- The electric supply connection shall be made by a qualified electrician and comply with IEC60364-i.
- The electric supply to this appliance should include either a residual current device that will interrupt the supply if the leakage current to earth exceeds 30 mA for 30 ms or a device that will interrupt the earth circuit.
- **WARNING:** This appliance has been designed for use with the cleaning agent supplied or recommended by the manufacturer. The use of other cleaning agents or chemicals may adversely affect the safety of the appliance.



- **WARNING:** Do not use the appliance within range of persons unless they wear protective clothing.
- **WARNING:** High pressure jets can be dangerous if subject to misuse. The jet must not be directed at persons, live electrical equipment or the appliance itself.
- Do not direct the jet against yourself or others in order to clean clothes or foot-wear.
- Risk of explosion – do not spray flammable liquids.
- Disconnect from the electrical power supply before carrying out user maintenance.
- High pressure cleaners shall not be used by children or untrained personnel.
- To ensure appliance safety, use only original spare parts from the manufacturer or approved by the manufacturer.
- **WARNING:** Water that has flown through backflow preventers is considered to be non-potable.
- **WARNING:** The machine shall be disconnected from its power source during cleaning or maintenance and when replacing parts for mains operated machines by removing the plug from the socket-outlet!
- **WARNING:** High pressure hoses, fittings and couplings are important for safety of the appliance. Use only hoses, fittings and couplings recommended by the manufacturer.
- Do not use the appliance if a supply cord or important parts of the appliance are damaged, e.g. safety devices, high pressure hoses, trigger gun.
- **WARNING:** If an extension cord is used, the plug and socket must be of watertight construction.
- **WARNING:** Inadequate extension cords can be dangerous.
- This high pressure washer must not be used at temperatures below 0°C.

WARNING!

- Cord on drums should always be completely unwound to prevent the cord from overheating. If an extension cord is used, the plug and socket must be of watertight construction.
- Inadequate extension cords can be dangerous.
- Comply with the below-mentioned requirements for length and cord dimensions.

1.0 mm ²	max. 12.5 m
1.5 mm ²	max. 20 m
2.5 mm ²	max. 30 m

Power cord connections should be kept dry and off the ground.

- If the power cord is damaged, it must be replaced by the manufacturer or his service agent or similarly qualified person in order to avoid a hazard.



Keep the machine on a stable and flat surface during operation, handling, transportation and storage. Sudden overturn of the machine may cause injury to body.

In the event of accident or breakdown, switch off the machine immediately (e.g. contact with detergent: rinse with an abundance of clean water)

Attention!

Through poor conditions of the electrical MAINS, shortly voltage drops can appear when starting the EQUIPMENT. This can influence other equipment (e.g. blinking of a lamp). If the MAINS-IMPEDANCE $Z_{max} < 0.335 \text{ OHM}$, such disturbances are not expected (if this is the case you may contact your local supply authority for further information).

WARNING! ELECTRICAL SHOCK HAZARD



Improper connection of the equipment-grounding conductor can result in a risk of electrical shock. Check with a qualified electrician or service person if you are unsure if an outlet is properly grounded. DO NOT modify the plug provided with the appliance to fit an outlet, have a proper outlet installed by a qualified electrician.

Mains power connection



The following should be observed when connecting the high pressure washer to the electric installation:

- The electric installation shall be made by a certified electrician and comply with IEC-364.
- It is recommended that the electric supply to this appliance should include either a residual current device that will interrupt the supply if the leakage current to earth exceeds 30 mA for 30 ms.

IMPORTANT! Only use water without any impurities.

If there is a risk of running sands in the inlet water (i.e. from your own well), an additional filter should be mounted.

Safety devices

- The unloader valve can reduce pressure if it exceeds pre-set values. The spray gun features a locking device. When the pawl is activated, the spray gun cannot be operated.

Thermal sensor:

A thermal sensor protects the motor against overloading. The machine will restart after a few minutes when the thermal sensor has cooled.



4. NAME OF PARTS: (FIG. 1)

- | | | |
|-----------------------|---------------------|----------------------|
| 1. Wheel | 6. Water outlet | 11. Warning label |
| 2. Spray lance | 7. On/Off switch | 12. Gun lock |
| 3. Spray gun | 8. Detergent switch | 13. Cord hook |
| 4. Trigger | 9. Water inlet | 14. Rating label |
| 5. High pressure hose | 10. Power cord | 15. Detergent bottle |

5. PRODUCT DESCRIPTION

PURPOSE

- The high pressure water cleaner is designed to clean vehicles, machines, buildings, facades, etc. in the private sector.

AREAS OF APPLICATION

- Never use the machine in potentially explosive areas under any circumstances!
- The operating temperature must be between 0 and +40°C.
- The machine consists of an assembly with a pump, which is encased in shock absorbing housing. For an optimal working position the machine comes with a lance and a non-slip handle grip, whose shape and configuration comply with the applicable regulations.
- Do not cover or modify the lance or the spray nozzles in any way.
- The high pressure water cleaner is designed to be used with cold or lukewarm (max. 60°C); higher temperatures can damage the pump.
- Do not use water that is dirty, gritty or contains any chemical products, as these could impair operation and shorten the life of the machine.
- Accessories can be used to carry out work with foam cleaners, sand spraying.

6. ASSEMBLY

- Position the washer as NEAR as possible to the water supply.
- The washer must be used standing on a secure, stable, and positioned as shown. FIG.2.
- Fit the lance into the gun and rotating it until the two parts are completely locked FIG. 3
- Connect the gun to the high pressure hose FIG.4
- Connect the high pressure hose to the water outlet on the washer FIG.5.
- Connect the water supply hose to female coupler FIG.6, then connect to the water inlet of the washer. The supply hose must have an internal diameter of at least 13mm (1/2 in.) and must be reinforced. The water supply must be at least equal to the washer delivery capacity.

NOTE: The machine not suitable for connection to the potable water main (FIG. 13).



WARNING

The intake water temperature must not exceed 40°C. The water supply must not exceed 0.7 MPa.



CAUTION

The washer must only be used with clean water; use of unfiltered water or corrosive chemicals will damage the washer.

- Push the motor switch to "OFF" position FIG. 8.
- Check that the electrical supply voltage and frequency (Volt/Hz) correspond to those specified on the washer rating plate. If the power supply is correct, you may now plug in the washer.

7. OPERATION

- Turn on the water supply tap fully.
- Release the safety lock FIG.7, then press the trigger for a few seconds to allow air to escape and to discharge residual pressure in the hose.
- Keeping the trigger pressed, push the switch to start the motor FIG.8.
- **When re-starting the motor, always keep the trigger pressed.**

NOTE: THE MOTOR ONLY RUNS WHEN THE TRIGGER IS OPERATED.

CORRECT USE OF STANDARD ACCESSORIES

- The washer is equipped with adjustable nozzles FIG.9.
- Jets vary from 0° to 40° and low pressure.

WARNING: DO NOT ADJUST THE NOZZLE WHILE THE TRIGGER IS SQUEEZED.

RECOMMENDED CLEANING PROCEDURE

- Dissolve dirt by applying detergent with the fan jet to the dry surface. On vertical surfaces, work from the bottom upwards. Leave the detergent to act for 1 to 2 minutes, but do not allow to dry out. Apply the high from the surface, working from the bottom upwards.
- Avoid allowing the rinsing water to run on to unwanted surfaces.

STORAGE (FIG.10 – FIG. 12)

- Switch off the washer.
- Turn off the water supply tap.
- After use, the detergent residuals should be removed from the tank.
- Discharge residual pressure by pressing the trigger until no more water comes out of the lance nozzle.
- Engage the gun safety lock.
- Remove the plug from the socket.
- Operate the washer with non-corrosive/ non-toxic antifreeze before storing for the winter.



WARNING: BEFORE REUSING, COMPLETELY FLUSH THE UNIT OUT WITH PLAIN WATER. ANTI-FREEZE CAN DAMAGE PAINTWORK SO YOU MUST ENSURE THERE IS NO ANTI-FREEZE LEFT IN THE SYSTEM BEFORE USING IT AGAIN.

8. MAINTENANCE



CAUTION

Before working on the washer, disconnect the lug from the power supply socket.

- To ensure good performance, check and clean the section and detergent filters after every 50 hours of operation FIG. 10.
- Clean the nozzle with the tool provided. Remove the lance from the gun; remove any dirt from the nozzle hole (FIG. 11) and rinse.

9. TROUBLE-SHOOTING

Disconnect from the electrical power supply before carrying out user maintenance or checking its correct functioning. Please check the following before contacting the service organisation:

Machine refuses to start	Machine not plugged in Defective socket Fuse has blown Defective extension cord	Plug in machine Try another socket Replace fuse Switch off other machines Try without the extension cord
Fluctuating pressure	Pump sucking air Valves dirty, worn out or stuck Pump seals worn out	Check that hoses and connections are airtight Clean and replace or refer to local distributor
Machine stops	Fuse has blown Incorrect mains voltage Thermal sensor activated Nozzle partially blocked	Replace fuse. Switch off other machines. Check that the mains voltage corresponds to specification on the model tag. Leave the washer for 5 minutes to cool down. Clean the nozzle
Fuse blows	Fuse too small	Change to an installation higher than the amp. consumption of the machine. You may try without the extension cord.
Machine pulsating	Air in inlet hose Inadequate supply of mains water Nozzle partially blocked Water filter blocked Hose kinked	Allow machine to run with open trigger until regular working pressure resumes. Check that the water supply corresponds to specifications required NB! Avoid using long, thin hoses (min. 1/2") Clean the nozzle Clean the filter Straighten out hose.

Machine often starts and stops by itself	Pump/spray gun is leaking Centre.	Contact your nearest Service Centre.
Machine starts, but no water comes out	Pump/hoses or accessory frozen No water supply Water filter blocked Nozzle blocked	Wait for pump/hoses or accessory to thaw. Connect inlet water. Clean the filter Clean the nozzle

In case problems other than the above occur, please contact your local distributor.

10. CIRCUIT DIAGRAM

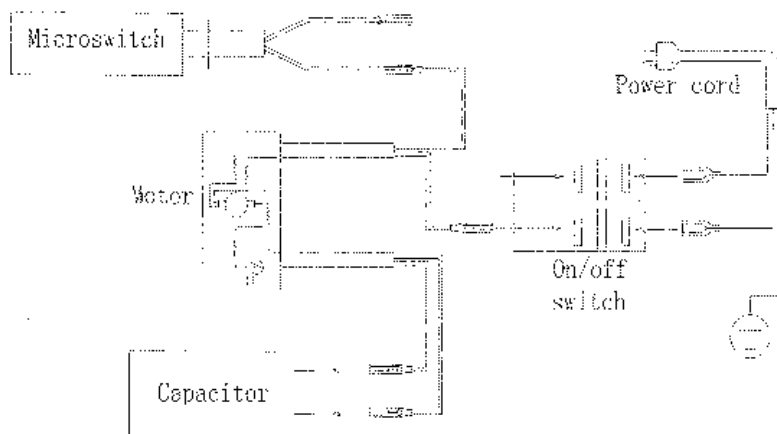

11. DISPOSAL

Recycling the washer



Do not dispose of electrical appliances as unsorted municipal waste, use separate collection facilities.

Contact local government for information regarding collection systems available.

If electrical appliances are disposed of in landfills or dumps, hazardous substances can leak into the groundwater and get into the food chain, damaging your health and well-being.

When replacing old appliances with new ones, the retailer is legally obligated to take back your old appliance for disposal at least free of charge.



12. WARRANTY SERVICE

1. This Product has been manufactured to a high quality standard. The warranty period is 3 month from date of purchasing.
2. For warranty service, please contact the present the warranty card and the original invoice for the warranty service.
3. This warranty DOES NOT apply to:
 - O-rings, seals, valves, nozzles, filters.
 - Damages to high pressure hose, gun, pump, motor, housing shells due to misuse, operation errors, or exposure to natural elements.
 - Transportation damages after sales.
 - Services not provided by our authorized service centers.
 - Accessories and spare parts, if any, provided in the package.
 - Damage resulted from commercial or industrial use, as this product is intended for DIY use only.

PLEASE SAVE THESE INSTRUCTIONS



JETWAVE RAIDER 8.130 USER MANUAL AMENDMENTS

Please note that the warranty period is 12 months and not 3 months as stated in the user manual.

Please note that the turbo nozzle shown in Figures 9 and 11 are optional accessories and not provided with the unit as standard.