

RAPTOR™ G2 JNR



3000
200 BAR
PSI

11
L/PM

HONDA GX200
PETROL
ENGINE TYPE
POWERED BY HONDA.

DIRECT
3400RPM
DRIVE

COLD
WATER
OUTPUT



HERO INNOVATIONS

-  **PEXO™**
Stainless Steel Exoskeleton
-  **TLL™**
Top Lifting Lug
-  **AFW™**
Anti Flat Wheels
-  **AVPS™**
Anti Vibration Protection System
-  **JWPP™**
Jetwave™ AR® Premium Pump





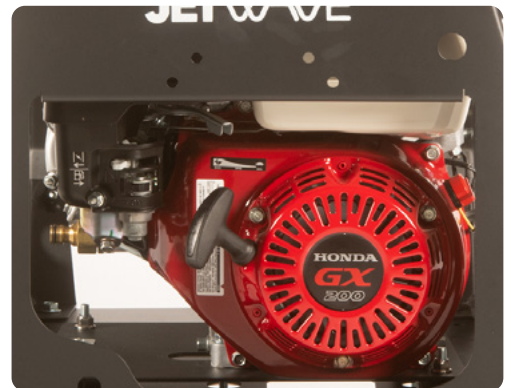

Registered Design © 202215871

APPLICATIONS

-  Agriculturist
-  Domestic Cleaning
-  Light Work Tradesmen
-  Light Work Commercial Cleaners



STANDOUT FEATURES

-  JW® Premium AR® triplex pump delivers better performance and longevity.
-  Industrial Honda™ GX200 pull start series engine that delivers performance and reliability.
-  Jetwave Safety System™ (JSS) thermal and safety valve to prevent overheating in excessive bypass and over pressurisation.
-  Soft grip handle ergonomic and compact.
-  DIY water filter and tie down points for a secure transportation.
-  Tool free dual M22 screw hose coupling system.

STANDARD EQUIPMENT



Gun/Lance: J5000™ High Pressure Gun w/swivel + lance w/variable pressure control.



Hose: 10m non marking double wire braid hose w/M22 couplings.



Chemical: In-line chemical downstream injector w/strainer.

DIMENSIONS (MM)

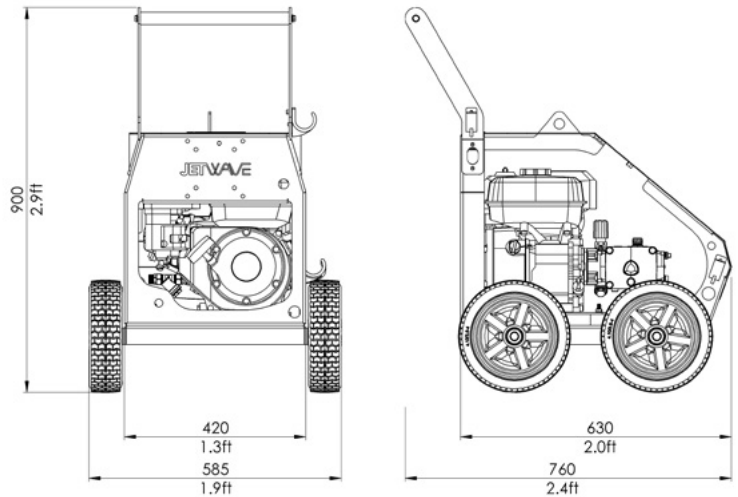

TECHNICAL DATA 0:00

RAPTOR™ G2 JNR

Product Code	CW3000-11PX-G2
Pressure / Flow Rate	3000PSI (200 BAR) / 11 L/PM (660 L/PH) / 2.9 GPM
Max Inlet Temp	60°C / 140°F
Class (AS/NZS: 4223)	A (2,200 Bar/Litres)
Usage Frequency	Semi Professional: Weekly
Nozzle Size	03
Frame Structure	CNC Modular galvanised steel chassis, plus satin powder coat finish and stainless steel cover

MOTOR FEATURES

Engine / Power	Honda™ GX200 Pull Start (air cooled) 6.5HP / 200cc
Fuel Type / Capacity / Protection	Unleaded / 3.1L / Low Oil Shutdown

HYDRAULIC FEATURES

Pump / Head / Pistons	JW® AR® Triplex Plunger / Brass (Nickle Plated) / Ceramic
Motor Pump Coupling / Pump RPM	Direct Drive / 3400RPM
Unloader Valve	Banjo bolt on
Safety Valve	Yes
Detergent Injector	Yes - Downstream low pressure

DIMENSIONS & WEIGHT

Machine Dimensions / Weight	760mm(L) x 585mm(W) x 900mm(H) / 55KG
-----------------------------	---------------------------------------

WARRANTY(S)

Unit / Pump Warranty*	2 Years
Engine Warranty*	3 Years

OPTIONAL ACCESSORIES

30m Hose Reel w/30m hose	1060Cmpl-RAPJNR30M
JW3 Foaming Lance w/1L Tank	JWA221
Turbo Head w/Lance	JWA160.03
12" FSC - ABS Plastic	JWA-FSC12-CMPL

Copyright © 2024 Jetwave® Group Pty Ltd. All Rights Reserved.

The manufacturer reserves the right to modify design features and technical facts without notice, due to our principals of continuous improvement.
*Coverage against defects in material and workmanship (refer to Jetwave's and component partners T&Cs).

V4.0 07/24